

SG2M021120LH



TriQSiC™ 1200V Silicon Carbide Power MOSFET G2 (N Channel Enhancement)

Features

- High speed switching
- Very low switching losses
- Fully controllable dv/dt
- High blocking voltage with low on-resistance
- Fast intrinsic diode with low reverse recovery (Q_{rr})
- Temperature independent turn-off switching losses
- Halogen free, RoHS compliant

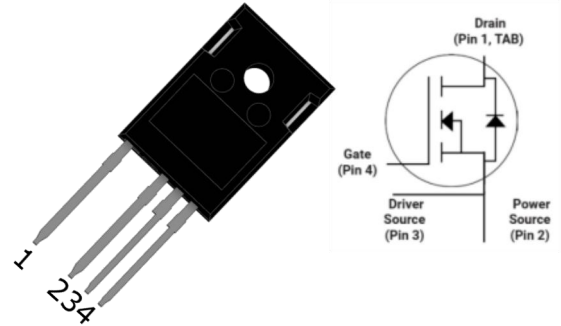

TO-247-4L

Benefits

- Cooling effort reduction
- Efficiency improvement
- Reduced cooling requirements
- Increased power density
- Increased system switching frequency



Applications

- On-board charger/PFC
- EV battery chargers
- Booster/DC-DC converter
- Switch mode power supplies

Table 1 Key performance and package parameters

Type	V _{DS}	I _{DS} (T _C = 25°C, R _{th(j-c),max})	R _{DS(on), typ} (V _{GS} = 15V, I _D = 64A, T _J = 25°C)	T _{J,max}	Marking	Package
SG2M021120LH	1200V	112A	21mΩ	175°C	SG2M021120LH	TO-247-4L

Table of contents

Table of contents

Features	1
Benefits	1
Applications	1
Table of contents	2
1、 Maximum ratings	3
2、 Thermal characteristics	3
3、 Electrical characteristics	4
3.1 Static characteristics	4
3.2 Dynamic characteristics	4
3.3 Switching characteristics	5
4、 Electrical characteristic diagrams	6
5、 Package drawing (TO-247-4L-C)	11
6、 Test conditions	12
Revision history	13
Attention	13

1、Maximum ratings

Table 2 Maximum rating ($T_c = 25^\circ\text{C}$ unless otherwise specified)

Symbol	Parameter	Value	Unit	Test Conditions	Note
$V_{DS,max}$	Drain source voltage	1200	V	$V_{GS} = 0V, I_D = 100\mu\text{A}$	
$V_{GS,max}$	Gate source voltage	-8 /+19	V	Absolute maximum values	Note1
V_{GSop}	Gate source voltage	-4 /+15	V	Recommended operational values	
I_D	Continuous drain current	112	A	$V_{GS} = 15V, T_C = 25^\circ\text{C}$	Fig.19
		79		$V_{GS} = 15V, T_C = 100^\circ\text{C}$	
$I_{D(pulse)}$	Pulsed drain current	328	A	Pulse width $t_p = 100\mu\text{s}$ limited by $T_{J,max}$	Fig.22
P_D	Power dissipation	441	W	$T_C = 25^\circ\text{C}, T_J = 175^\circ\text{C}$	Fig.20
T_J, T_{stg}	Operating Junction and storage temperature	-55 to +175	$^\circ\text{C}$		
T_L	Soldering temperature	260	$^\circ\text{C}$	1.6mm (0.063") from case for 10s	
T_M	Mounting torque	1	Nm	M3 or 6-32 screw	
		8.8	lbf-in		

Note 1: when using MOSFET Body Diode $V_{GS,max} = -4 / +19V$

2、Thermal characteristics

Table 3 Thermal characteristics

Symbol	Parameter	Min.	Typ.	Max.	Unit	Test Conditions	Note
$R_{th(j-c)}$	Thermal resistance from junction to case	-	0.27	0.34	$^\circ\text{C/W}$	-	Fig.21

3、Electrical characteristics

3.1 Static characteristics

Table 4 Static characteristics (Tc = 25°C unless otherwise specified)

Symbol	Parameter	Min.	Typ.	Max.	Unit	Test Conditions	Note
$V_{(BR)DSS}$	Drain-source breakdown voltage	1200	-	-	V	$V_{GS} = 0V, I_D = 100\mu A$	
$V_{GS(th)}$	Gate threshold voltage	2.3	2.8	3.6	V	$V_{DS} = V_{GS}, I_D = 18mA$	Fig.11
		-	2.2	-	V	$V_{DS} = V_{GS}, I_D = 18mA$ $T_J = 175^\circ C$	
I_{DSS}	Zero gate voltage drain current	-	1	10	μA	$V_{DS} = 1200V, V_{GS} = 0V$	
I_{GSS}	Gate source leakage current	-	-	100	nA	$V_{GS} = 15V, V_{DS} = 0V$	
$R_{DS(on)}$	Current drain-source on-state resistance	-	20	28	m Ω	$V_{GS} = 15V, I_D = 64A$	Fig.4,5,6
			35			$V_{GS} = 15V, I_D = 64A,$ $T_J = 175^\circ C$	
gfs	Transconductance	-	44	-	S	$V_{DS} = 20V, I_D = 64A$	Fig.7
		-	42	-		$V_{DS} = 20V, I_D = 64A,$ $T_J = 175^\circ C$	
$R_{g,int}$	Intenal gate resistance	-	3.3	-	Ω	$V_{AC} = 25mV, f = 1MHz,$ open drain	

3.2 Dynamic characteristics

Table 5 Dynamic characteristics (Tc = 25°C unless otherwise specified)

Symbol	Parameter	Min.	Typ.	Max.	Unit	Test Conditions	Note
C_{iss}	Input capacitance	-	4130	-	pF	$V_{DS} = 1000V, V_{GS} = 0V$ $T_J = 25^\circ C, V_{AC} = 25mV$ $f = 100kHz$	Fig.17,18
C_{oss}	Output capacitance	-	189	-			
C_{rss}	Reverse capacitance	-	9	-			
E_{oss}	Coss stored energy	-	101	-	μJ		Fig.16

1200V SiC Power MOSFET

Q_{gs}	Gate source charge	-	41	-	nC	$V_{DS} = 800V, V_{GS} = -4/+15V$ $I_D = 64A$	Fig.12
Q_{gd}	Gate drain charge	-	37	-			
Q_g	Gate charge	-	119	-			

3.3 Switching characteristics

Table 6 Dynamic characteristics($T_c = 25^\circ C$ unless otherwise specified)

Symbol	Parameter	Min.	Typ.	Max.	Unit	Test Conditions	Note
E_{on}	Turn on switching energy	-	1032	-	μJ	$V_{DS} = 800V, V_{GS} = -4/+15V$ $I_D = 64A, R_g = 2.5\Omega$ $L = 16.7\mu H$	Fig.26
E_{off}	Turn off switching energy	-	274	-			
$t_{d(on)}$	Turn on delay time	-	31	-	ns		Fig.27
t_r	Rise time	-	24	-			
$t_{d(off)}$	Turn off delay time	-	45	-			
t_f	Fall time	-	11	-			

Table 7 Body diode characteristics

Symbol	Parameter	Min.	Typ.	Max.	Unit	Test Conditions	Note
V_{SD}	Diode forward voltage	-	4.0	-	V	$V_{GS} = -4V, I_{SD} = 32A$	Fig.8,9, 10
		-	3.5	-	V	$V_{GS} = -4V, I_{SD} = 32A$ $T_J = 175^\circ C$	
I_S	Continuous diode forward current	-	98	-	A	$V_{GS} = -4V, T_c = 25^\circ C$	Note2
t_{rr}	Reverse recovery time	-	45	-	ns	$V_R = 800V, V_{GS} = -4V$ $I_{SD} = 64A$ $di/dt = 2341A/\mu s$ $T_J = 175^\circ C$	
Q_{rr}	Reverse recovery charge	-	740	-	nC		
I_{rrm}	Peak reverse recovery current	-	29	-	A		

Note 2: When using SiC Body Diode the maximum recommended $V_{GS} = -4V$

4、Electrical characteristic diagrams

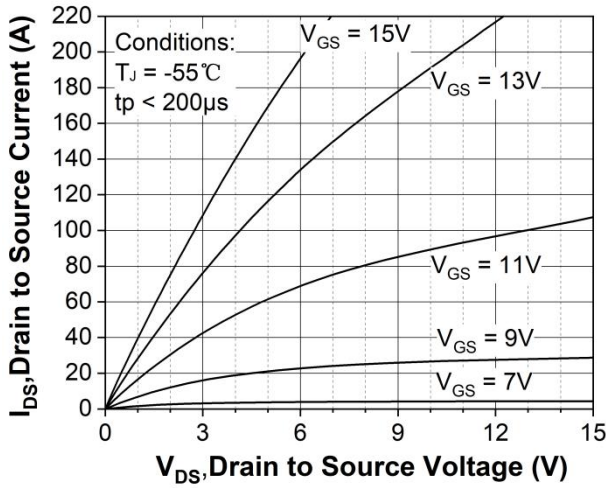

Figure 1. Output characteristics $T_J = -55^\circ\text{C}$

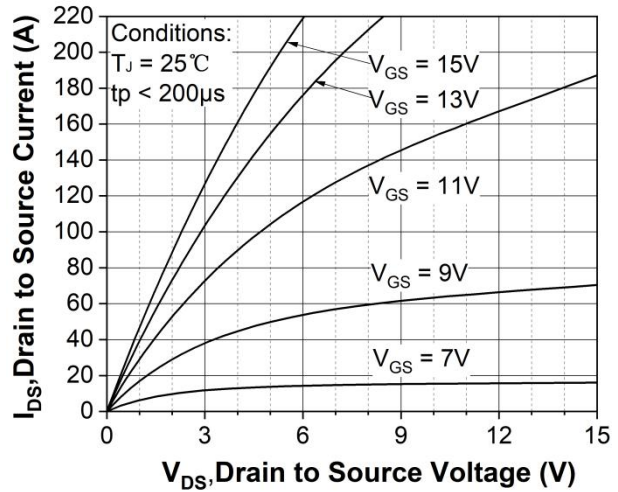

Figure 2. Output characteristics $T_J = 25^\circ\text{C}$

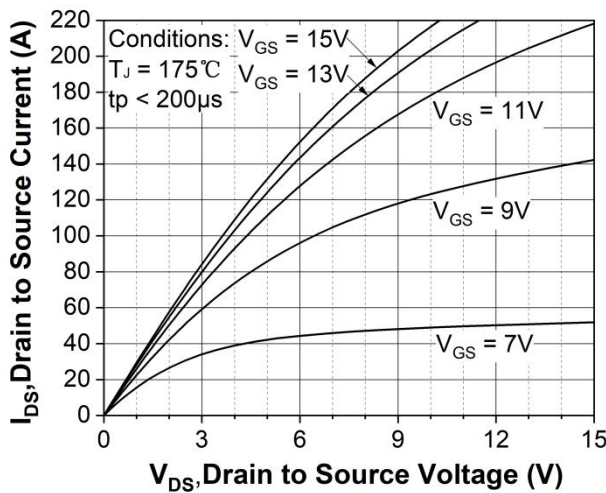

Figure 3. Output characteristics $T_J = 175^\circ\text{C}$

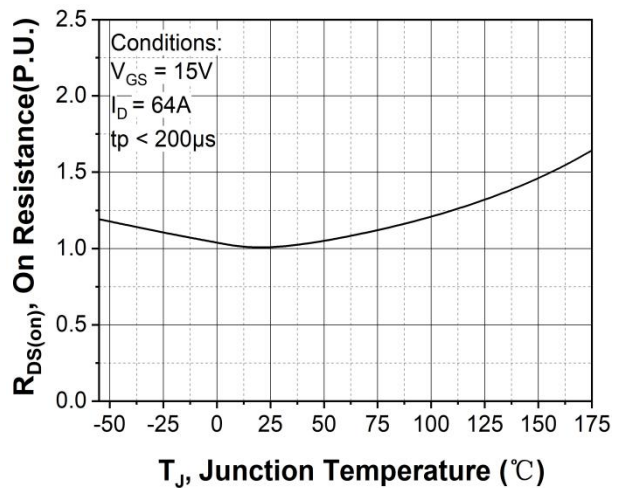

Figure 4. Normalized on-resistance vs. temperature

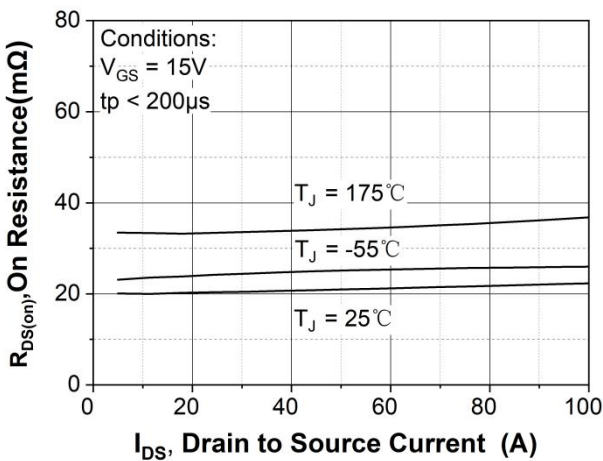

Figure 5. On-resistance vs. drain current

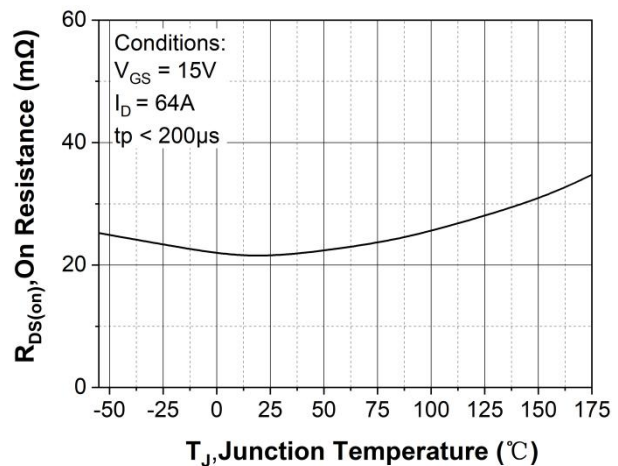

Figure 6. On-resistance vs. temperature

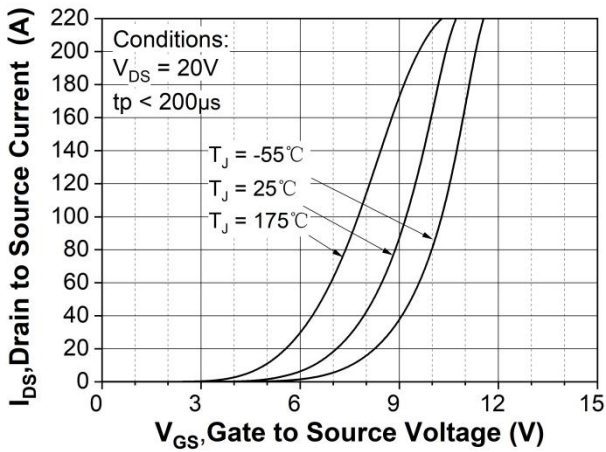

Figure 7. Transfer characteristic for various junction temperatures

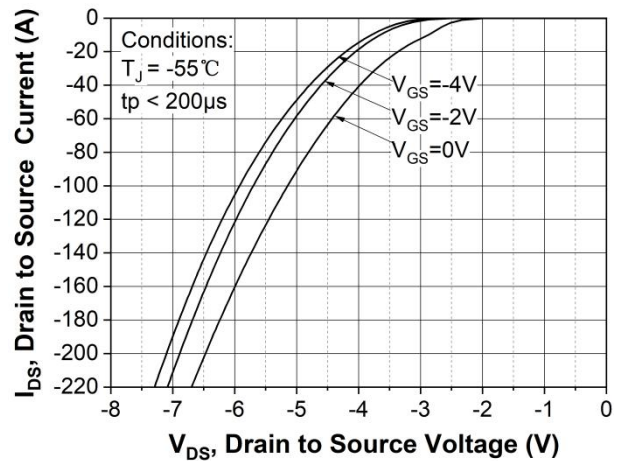

Figure 8. Body diode characteristic at $T_J = -55\text{ }^\circ\text{C}$

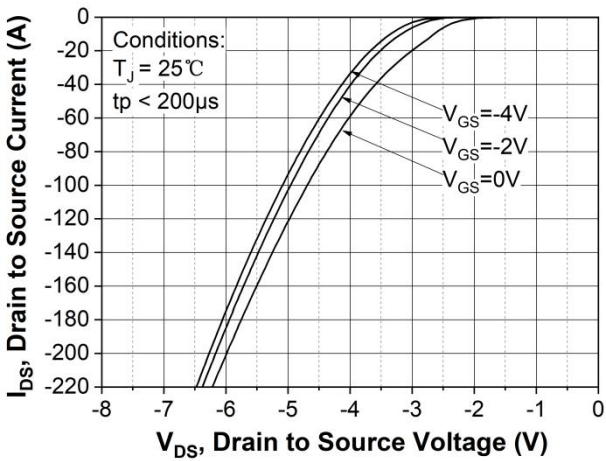

Figure 9. Body diode characteristic at $T_J = 25\text{ }^\circ\text{C}$

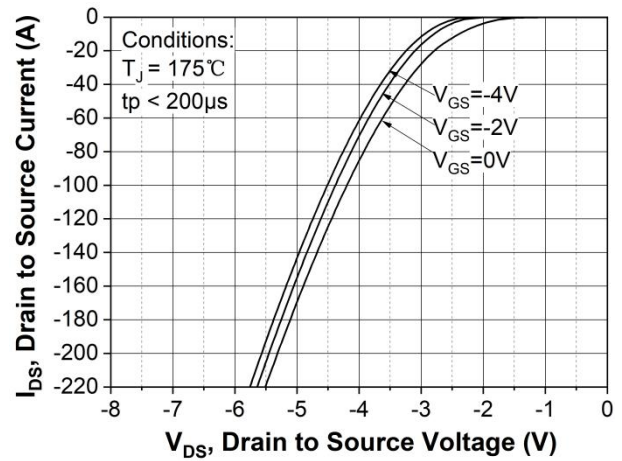

Figure 10. Body diode characteristic at $T_J = 175\text{ }^\circ\text{C}$

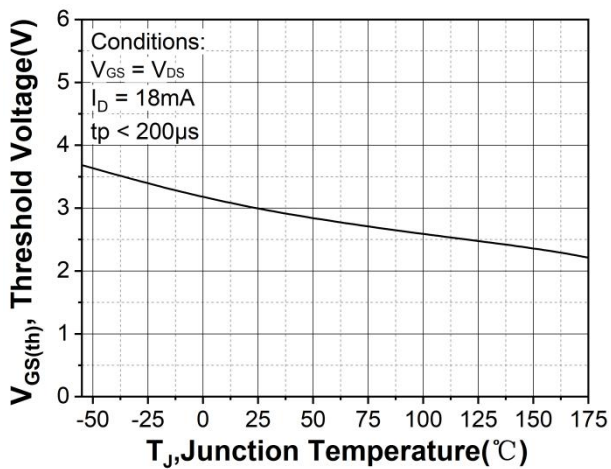

Figure 11. Threshold voltage vs. temperature

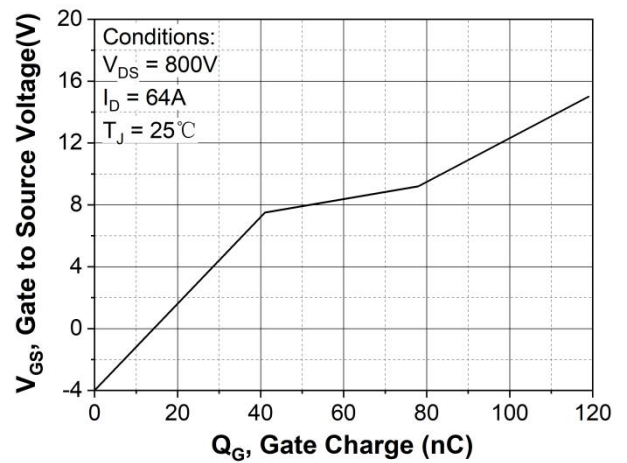

Figure 12. Gate charge characteristic

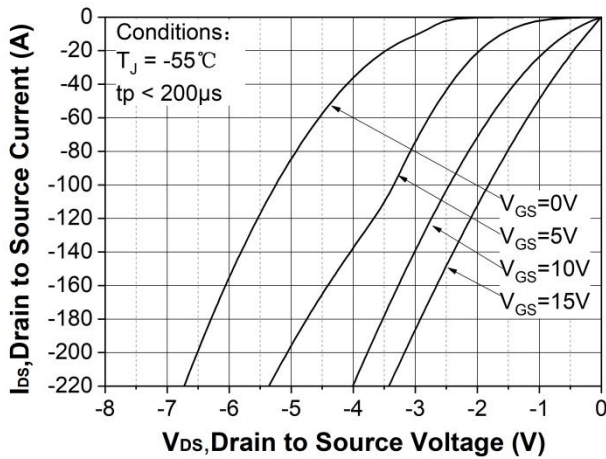

Figure 13. 3rd quadrant characteristic at $T_J = -55^\circ\text{C}$

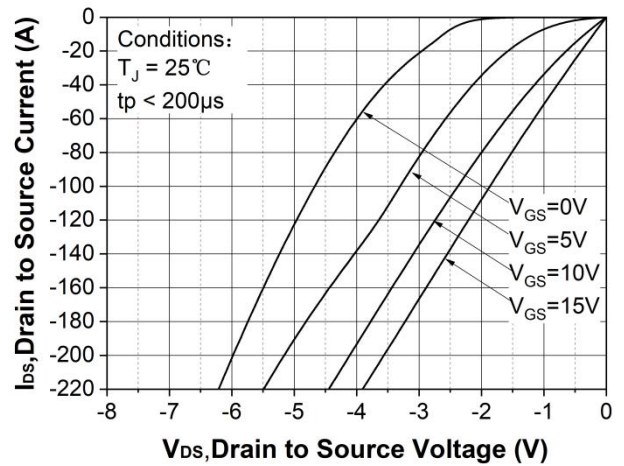

Figure 14. 3rd quadrant characteristic at $T_J = 25^\circ\text{C}$

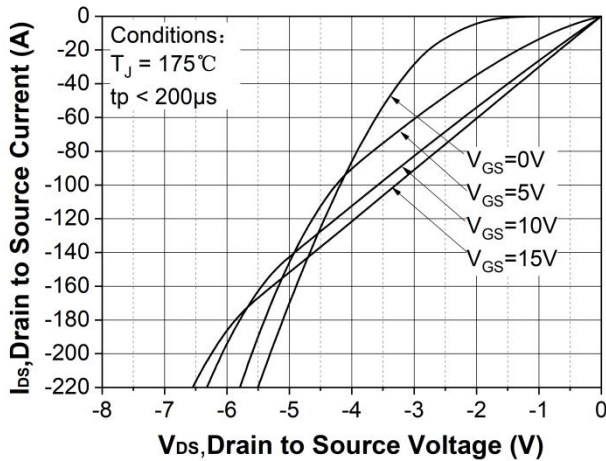

Figure 15. 3rd quadrant characteristic at $T_J = 175^\circ\text{C}$

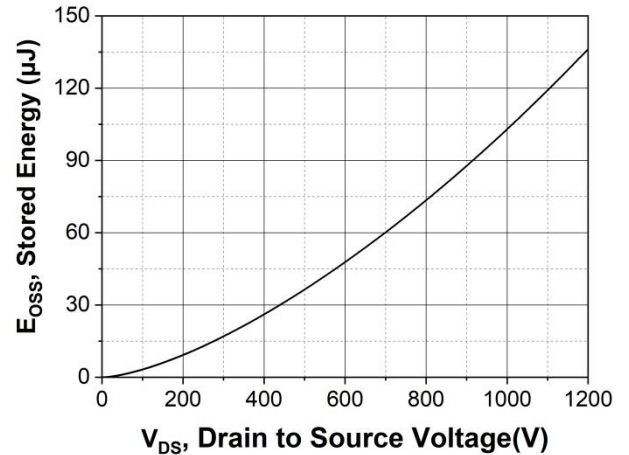

Figure 16. Output capacitor stored energy

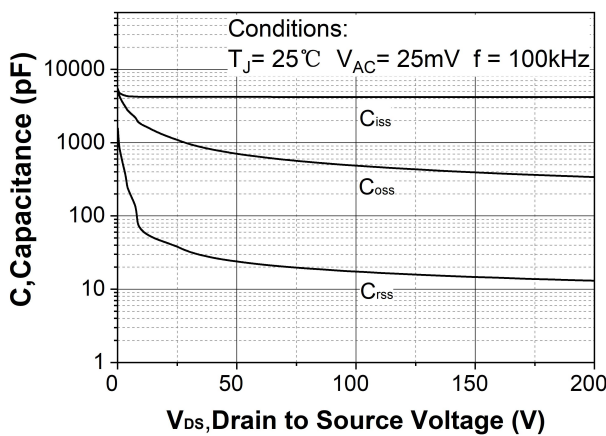

Figure 17. Capacitances vs. drain-source voltage (0 - 200V)

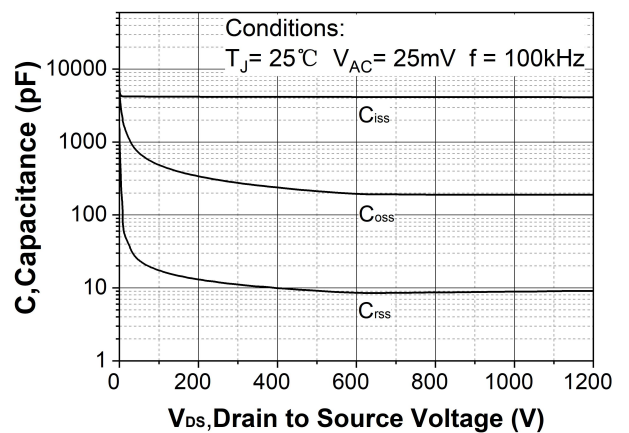

Figure 18. Capacitances vs. drain-source voltage (0 - 1200V)

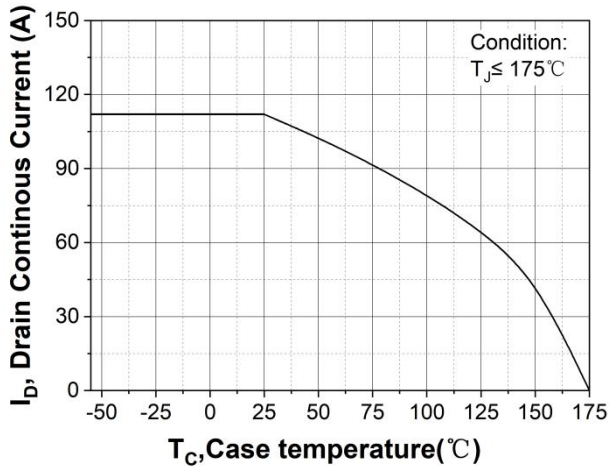

Figure 19. Continuous drain current derating vs. case temperature

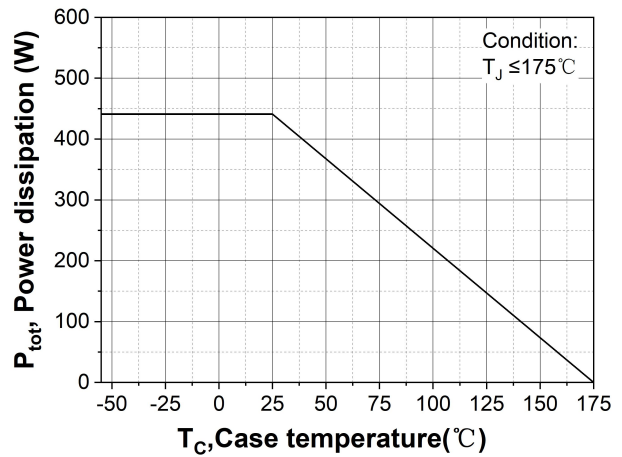

Figure 20. Maximum power dissipation derating vs. case temperature

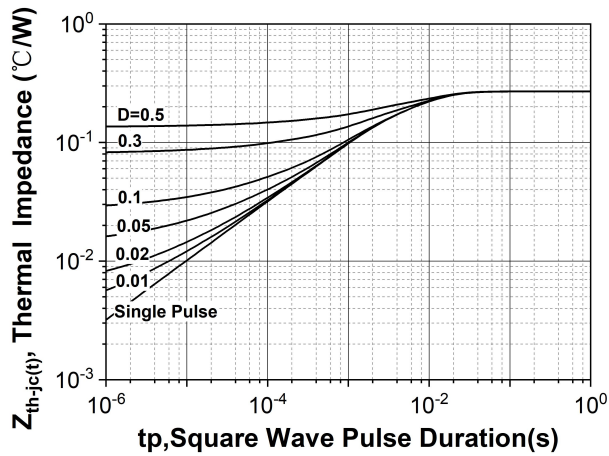

Figure 21. Transient thermal impedance (junction - case)

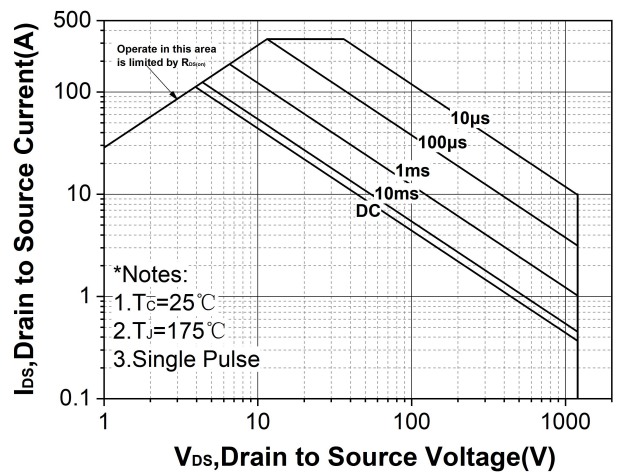

Figure 22. Safe operating area

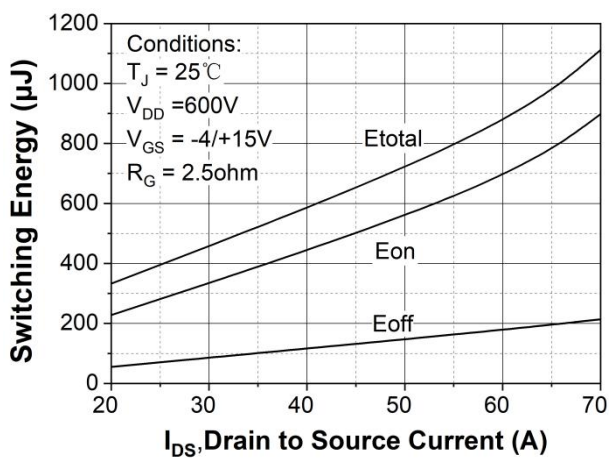

Figure 23. Clamped inductive switching energy vs. drain current ($V_{DD} = 600V$)

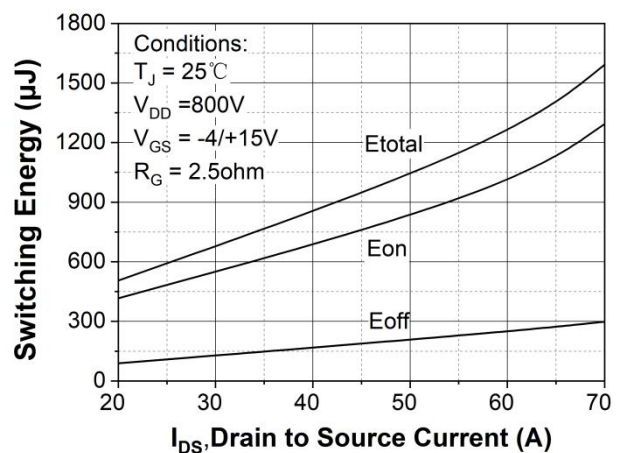

Figure 24. Clamped inductive switching energy vs. drain current ($V_{DD} = 800V$)

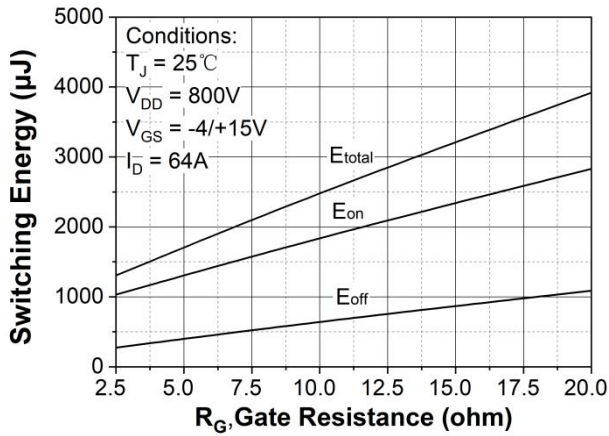

Figure 25. Clamped inductive switching energy vs. $R_G(\text{ext})$

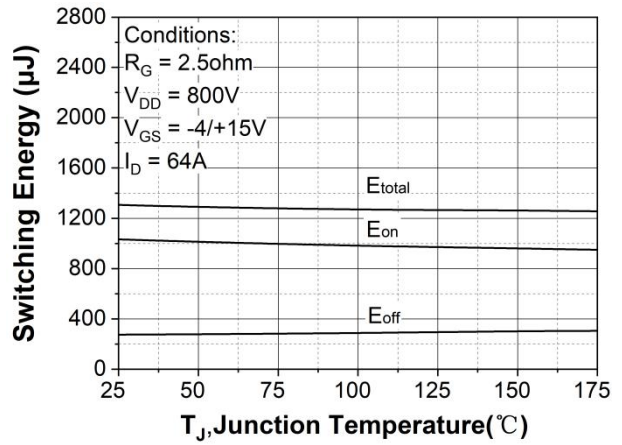

Figure 26. Clamped inductive switching energy vs. temperature

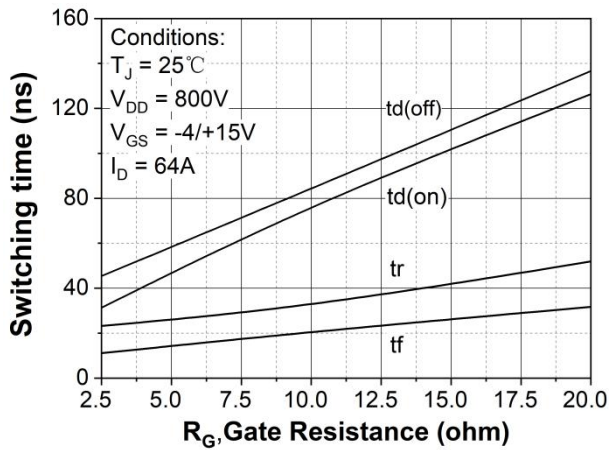

Figure 27. Switching times vs. $R_G(\text{ext})$

SG2M021120LH



1200V SiC Power MOSFET

5、 Package drawing (TO-247-4L-C)

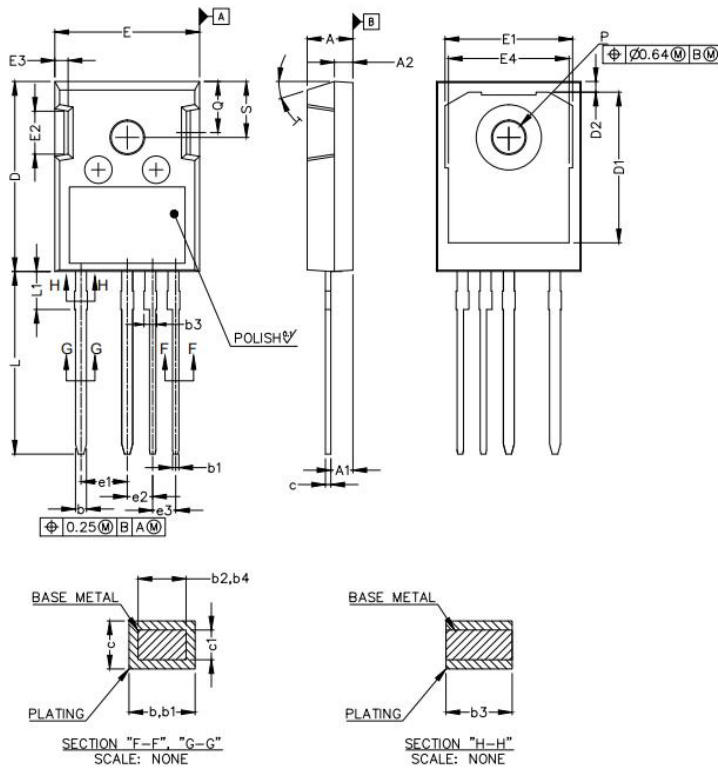

- NOTE :
1. ALL METAL SURFACES: TIN PLATED, EXCEPT AREA OF CUT
 2. DIMENSIONING & TOLERANCEING CONFIRM TO ASME Y14.5M-1994.
 3. ALL DIMENSIONS ARE IN MILLIMETERS. ANGLES ARE IN DEGREES.

SYM	MILLIMETERS	
	MIN	MAX
A	4.83	5.21
A1	2.29	2.54
A2	1.91	2.16
b	1.10	1.30
b1	0.65	0.79
b2	1.10	1.25
b3	1.34	1.44
b4	0.65	0.74
c	0.55	0.68
c1	0.55	0.65
D	20.80	21.10
D1	16.25	17.65
D2	0.95	1.25
E	15.75	16.13
E1	13.10	14.15
E2	4.32	5.10
E3	1.00	1.90
E4	12.38	13.43
e1	5.08 BSC	
e2	2.79 BSC	
e3	2.54 BSC	
L	19.72	20.32
L1	3.97	4.37
øP	3.51	3.65
Q	5.49	6.00
S	6.04	6.30
T	17.5° REF.	

6、 Test conditions

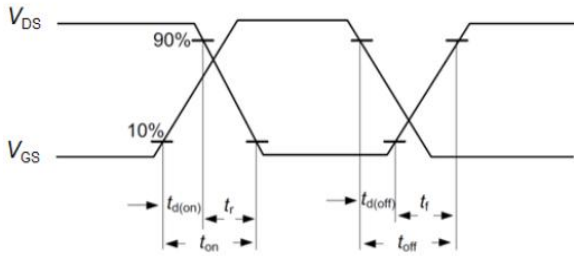

Figure A. Definition of switching times

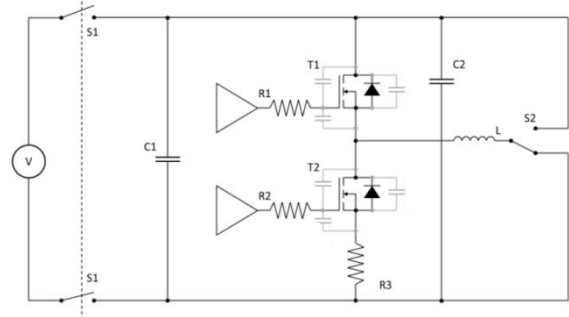

Figure B. Dynamic test circuit

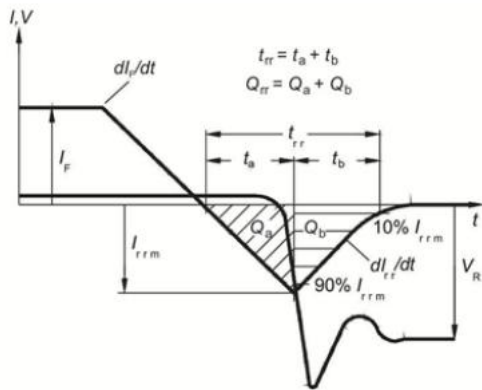

Figure C. Definition of body diode switching characteristics

Revision history

Document version	Date of release	Document stage	Description of changes
V01_00	2024-11-21	--	--
V01_01	2025-12-25	Final	--

Attention

1. RoHS compliance

The levels of RoHS restricted materials in this product are below the maximum concentration values (also referred to as the threshold limits) permitted for such substances, or are used in an exempted application, in accordance with EU Directive 2011/65/ EC (RoHS2), as implemented January 2, 2013.

2. REACH compliance

REACH substances of high concern (SVHCs) information is available for this product. Since the European Chemical Agency (ECHA) has published notice of their intent to frequently revise the SVHC listing for the foreseeable future, please contact a Sichain representative to insure you get the most up-to-date REACH SVHC Declaration. REACH banned substance information (REACH Article 67) is also available upon request.

3. With respect to information regarding the application of the product, Sichain hereby disclaims any and all warranties and liabilities of any kind, including without limitation warranties of non-infringement of intellectual property rights of any third party.

4. Any information given in this documents subject to customer's compliance with its obligations and any applicable legal requirements, norms and standards concerning any use of the product of Sichain in any customer's applications.

5. Specifications of any and all products described or contained herein stipulate the performance, characteristics, and functions of the described products in the independent state, and are not guarantees of the performance, characteristics, and functions of the described products as mounted in the customer's products or equipment.

6. Due to technical requirements products may contain dangerous substances. For information on the types in question please contact Sichain office.

7. Except as otherwise explicitly approved by Sichain in a written document signed by authorized representatives of Sichain, Sichain' products may not be used in any applications where a failure of the product or any consequences of the use thereof can reasonably be expected to result in personal injury.

8. For use of our products in applications requiring a high degree of reliability (as exemplified below), please contact and consult with a Sichain representatives, for example but not limited to: transportation equipment, primary communication equipment, traffic lights, fire/crime prevention, safety equipment, medical systems, and power transmission systems.